



Harrier 48 Autodrive VS

CODE474A OPERATOR MANUAL

Original Version (EN)
Issued: 28/01/2019

From Serial Number: 404000000 and Up
Part number: 3428-778 Rev B

CONTENTS

Introduction	5
Safety	6 - 9
General Safety	6
Safety Alert Symbol	6
Before Operation Safety	6 - 7
- General Safety	6
- Fuel Safety	7
During Operation Safety	7 - 8
- General Safety	7
- Slope Safety	8
After Operation Safety	8 - 9
- General Safety	8
Operation Safety	8
- Hauling Safety	8
Maintenance Safety	8
Safety & Instructional Decals	9
Product Overview	10
Product Specification	10
Setup	11 - 12
Delivery Checklist	11
Assembling and Unfolding the Handle	11
Grass Bag Assembly	11
Prevent Engine Damage	11
Engine Detail	12
Filling the Engine with Oil	12
Engine Oil Specifications	12
Before Operation	13 - 14
Fuel Type & Filling the Tank	13
Checking the Engine-Oil Level	13
Adjusting the Cutting Height	14

Before Operation continued	
Non Grassed Areas	14
Controls	14
Before Mowing	14
During Operation	15 - 16
Starting	15
Forward Travel	15
Shutting off the Engine	15
Parking	15
Turning	15
Trim Side Cutting	15
Vari-Pitch™ Cutting Technology	16
Heavy Growth	16
Grass Bag	16
Mowing without the Grass Bag	16
Friction Disc	16
After Operation	17
Cleaning the Mower	17
Folding the Handle	17
Maintenance Schedule	18
Maintenance	19 - 22
Preparing for Maintenance	19
Air Filter Service	19
Changing the Engine Oil	20
Servicing the Spark Plug	20
Remove & Replace the Blade	21
Blade Sharpening	21
Clutch Cable Adjustment	22
Securing Nuts & Bolts	22
Rear Deflector	22

CONTENTS

Maintenance continued	
Carburetor Adjustments	22
Blade Brake Test	22
Lubrication	22
Storage	23
Storage Safety	23
Preparing the Mower for Storage	23
Storage	23
Removing the Mower from Storage	23
Trouble Shooting	24
Warranty	25
EU Privacy Statement	26
Notes	26 - 28

INTRODUCTION

Thank you for purchasing a Hayter mower.

The following pages are designed to help you gain safe and efficient service from your mower.

This rotary-blade, walk-behind lawn mower is intended to be used by residential homeowners. It is designed primarily for cutting grass on well-maintained lawns on residential properties. Using this product for purposes other than its intended use could prove dangerous to you and bystanders.

This operator's manual should be regarded as part of the mower as it gives essential information regarding safety, operation, maintenance and specifications. If you misplace your operator's manual, contact your local Authorised Hayter Service Dealer for a replacement. Alternatively, visit www.hayter.co.uk/handbooks to download an electronic version.

To ensure maximum safety, best performance, and to gain knowledge of the mower, it is essential that you and any other operator read and understand the contents of this handbook before the engine is started. If you are unsure of any procedure detailed in this handbook then please contact your local Authorised Hayter Service Dealer for assistance.

Throughout this handbook all references to left and right are as viewed from behind the handle, in the direction of forward travel.

For engine details related to your product, please refer to the engine handbook provided.

Hayter Limited have designed and tested this mower for reasonably safe service; however, failure to comply with the instructions in this handbook may result in personal injury.

This mower is designed solely for use in a domestic grass cutting environment. Use in any other way is considered as contrary to the intended use.

Hayter Limited reserves the right to amend product specifications without prior notification.

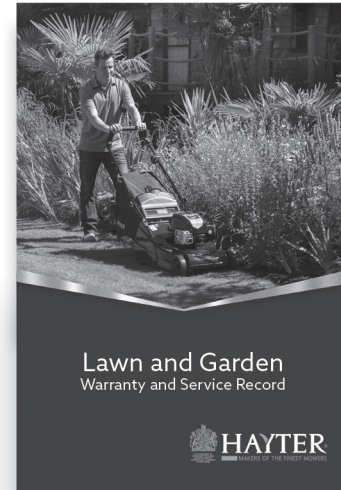

KEEP IT SAFE

You will find

- » Annual service record
- » Helpful lawnmower maintenance tips
- » Range of lawnmower accessories

If you did not receive a copy when you purchased your lawnmower, please contact your supplying dealer.

SAFETY

General Safety

This mower has been designed in accordance with EN ISO 5395-2:2017.

This product is capable of amputating hands and feet and of throwing objects. Always follow all safety instructions to avoid serious personal injury.

- Read, understand and follow the instructions and warnings in this Operator's Manual, on the mower and attachments before starting the engine.
- Use your full attention while operating the mower. Do not engage in any activity that causes distractions; otherwise, injury or property damage may occur.
- Do not put your hands or feet near moving parts of or under the mower. Keep clear of any discharge opening.
- Do not operate the mower without all guards and other safety protective devices in place and working on the mower.
- Keep bystanders and children out of the operating area. Do not allow children to operate the mower. Allow only people who are responsible, trained, familiar with the instructions, and physically capable to operate the mower.
- Stop the mower, shut off the engine and wait for all moving parts to stop before servicing, fuelling, or unclogging the mower.

Improperly using or maintaining this mower can result in injury. To reduce the potential for injury, comply with these safety instructions and always pay attention to the safety-alert symbol, which means Caution, Warning, or Danger - personal safety instruction. Failure to comply with these instructions may result in

personal injury or death.

You can find additional safety information where needed throughout this manual.

Safety Alert Symbol

This safety alert symbol indicates important safety messages. When you see this symbol be alert to the possibility of injury. Carefully read the following and inform others.

Failure to observe the following precautions may result in serious injury.

Before Operation Safety - General Safety

- **Always shut off the engine. Wait for all movement to stop and allow the mower to cool before adjusting, cleaning, storing or repairing it.**
- **Become familiar with the safe operation of the equipment, operator controls, and safety signs.**
- **Check that all guards and safety devices, such as deflectors and/or grass bag, are in place and working properly.**
- **Always inspect the mower to ensure that the blades, blade bolts, and cutting assembly are not worn or damaged.**
- **Inspect the area where you will use the mower and remove all objects that could interfere with the operation of the mower or that the mower could throw.**
- **Adjusting the cutting height may bring you into contact with the moving blade, causing serious injury.**

- Shut off the engine and wait for all moving parts to stop.
- Do not put your fingers under the housing when adjusting the cutting height.

SAFETY

Before Operation Safety - Fuel Safety

Fuel is extremely flammable and highly explosive. A fire or explosion from fuel can burn you and others and can damage property.

- **To prevent a static charge from igniting the fuel, place the container and/or mower directly on the ground before filling, not in a vehicle or on an object.**
- **Fill the fuel tank outdoors, in an open area, when the engine is cold. Wipe up any fuel that spills.**
- **Do not handle fuel when smoking or around an open flame or sparks.**
- **Do not remove the fuel cap or add fuel to the tank while the engine is running or hot.**
- **If you spill fuel, do not attempt to start the engine. Avoid creating a source of ignition until the fuel vapours have dissipated.**
- **Store fuel in an approved container and keep it out of the reach of children.**

Fuel is harmful or fatal if swallowed. Long-term exposure to vapours can cause serious injury and illness.

- **Avoid prolonged breathing of vapours.**
- **Keep your hands and face away from the nozzle and the fuel-tank opening.**
- **Keep fuel away from your eyes and skin.**

During Operation Safety - General Safety

- Wear appropriate clothing, including eye protection; long trousers, slip-resistant, substantial

footwear; and hearing protection. Tie back long hair, secure loose clothing, and do not wear loose jewellery.

- Do not operate the mower while ill, tired, or under the influence of alcohol or drugs.
- The blade is sharp; contacting the blade can result in serious personal injury. Shut off the engine and wait for all moving parts to stop before leaving the operating position.
- When you release the engine stop lever, the engine should shut off and the blade should stop within 3 seconds. If not, stop using your mower immediately and contact a Hayter Authorised Service Dealer.
- Keep bystanders, especially small children, out of the operating area. Stop the mower if anyone enters the area.
- Always look down and behind you before moving the mower in reverse.
- Operate the mower only in good visibility and appropriate weather conditions. Do not operate the mower when there is the risk of lightning.
- Wet grass or leaves can cause serious injury if you slip and contact the blade. Avoid mowing in wet conditions.
- Watch for holes, ruts, bumps, rocks, or other hidden objects. Uneven terrain could cause the mower to overturn or cause you to lose your balance or footing.
- Use extreme care when approaching blind corners, shrubs, trees, or other objects that may block your view.
- Before leaving the operating position, shut off the engine, and wait for all moving parts to stop.
- If the engine has been running the muffler will be hot and can severely burn you. Keep away from the

hot muffler.

- If the mower strikes an object or starts to vibrate, immediately shut off the engine, wait for all moving parts to stop, and disconnect the lead from the spark plug before examining the mower for damage. Make all necessary repairs and retrieve the object(s) before resuming operation.
- Check the grass bag components and the discharge chute frequently for any wear or deterioration and replace them with the manufacturer's recommended parts when necessary.
- Use accessories and attachments approved by Hayter Limited only.

SAFETY

During Operation Safety - Slope Safety



- Mow across the face of slopes; never up and down. Use extreme caution when changing direction on slopes.
- Do not mow on excessively steep slopes. Poor footing could cause a slip-and-fall accident.
- Mow with caution near drop-offs, ditches, or embankments.

After Operation Safety - General Safety



- Clean grass and debris from the mower to help prevent fires. Clean up oil or fuel spills.
- Allow the engine to cool before storing the mower in any enclosure.
- Never store the mower or fuel container where there is an open flame, spark, or pilot light, such as on a water heater or on other appliances.

Operation Safety - Hauling Safety

- Use care when loading or unloading the mower.
- Secure the mower from rolling.

Maintenance Safety

- Disconnect the spark plug lead from the spark plug before performing any maintenance procedure.
- Wear gloves and eye protection when servicing the mower.
- The blade is sharp; contacting the blade can result

in serious personal injury. Wear gloves when servicing the blade.

- Never tamper with safety devices. Check their proper operation regularly.
- Tipping the mower may cause the fuel to leak.
- Fuel is flammable and explosive, and can cause personal injury. Run the engine dry or remove the fuel with a hand pump; never siphon the fuel.
- To ensure optimum performance and continued safety certification of the mower, use only genuine Hayter replacement parts and accessories.
- Replacement parts and accessories made by other manufacturers could be dangerous, and such use could void the product warranty.

SAFETY

Safety & Instructional Decals

Please ensure all Safety Decals are secured on the mower before using the product.

If any of the decals are missing or not secure, do not use the mower, contact your local Authorised Hayter Service Dealer for replacements.

WARNING: Improper maintenance, use of non-conforming spare parts, or the removal or modification of the safety decals may cause death or serious injury.

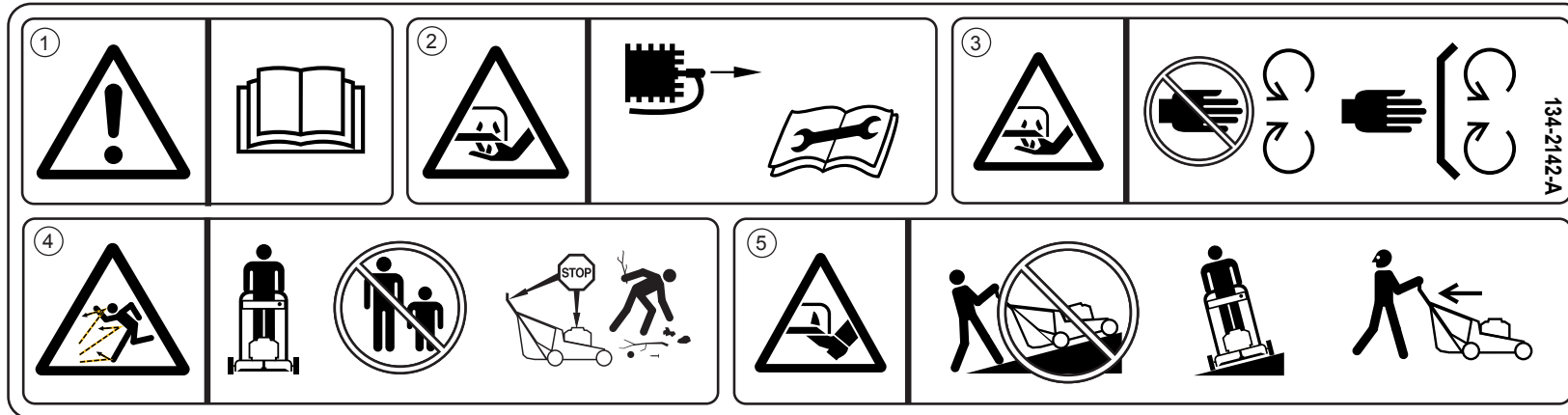

1. WARNING - Read Operator's Manual
2. Cutting/dismemberment hazard of hand, mower blade - disconnect the spark plug lead and read the instructions before servicing or performing maintenance.
3. Cutting/dismemberment hazard of hand, mower blade - stay away from moving parts; keep all guards and shields in place.
4. Thrown object hazard - keep bystanders out of the operating area of the mower and retrieve objects before resuming.
5. Cutting/dismemberment hazard of foot, mower blade - do not operate up and down slopes; operate side to side on slopes; look behind you when backing up.



Engine Stop

Moulded onto engine stop lever



Variable Speed Control

Printed on control

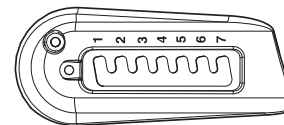

Height of Cut

Moulded in top cover



Easy Wash Port

Located on top cover

PRODUCT OVERVIEW

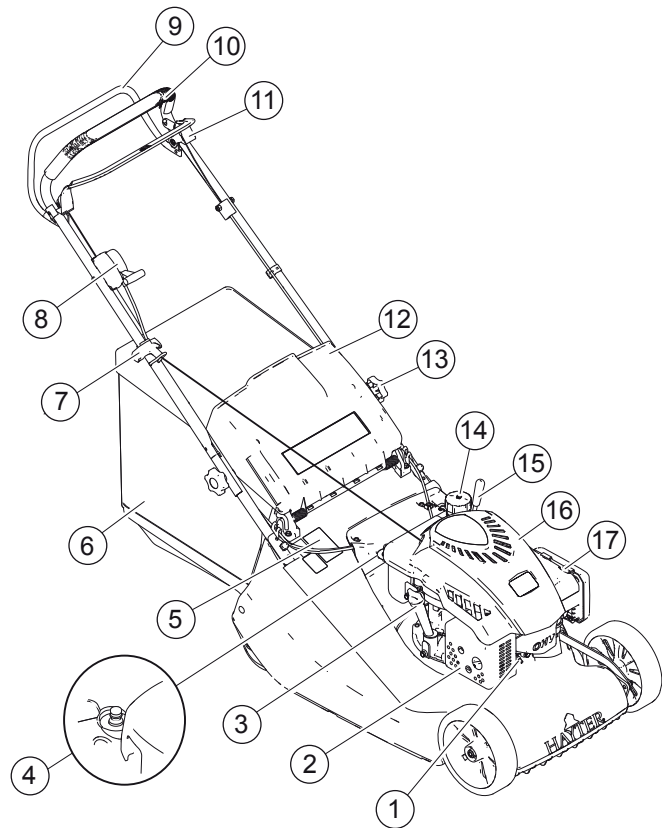

- | | |
|------------------------------|------------------------------|
| 1. Spark Plug and Lead | 10. Handle |
| 2. Exhaust Guard | 11. Engine Stop Lever |
| 3. Oil fill and Dipstick | 12. Rear Deflector |
| 4. Easy Wash Port | 13. Handle Securing Knob (2) |
| 5. Serial Number Label | 14. Fuel Tank and Cap |
| 6. Grass bag Assembly | 15. Height of Cut Lever |
| 7. Engine Start Cord | 16. Engine Cover |
| 8. Variable Speed Control | 17. Air Filter |
| 9. Ground Drive Clutch Lever | |

PRODUCT SPECIFICATION

Code	474A
Model	Harrier 48 Autodrive VS
Weight (Net)	47.4 kg
Length	1562 mm
Width	532 mm
Height	1039 mm
Width of Cut	480 mm
Height of Cut	13 - 60 mm
Engine Manufacturer	Hayter®
Engine Type	1P65FC (RECOIL)
Engine Power Rating (Net)	2.6 kW
Fuel Type*	Unleaded fuel
Fuel Capacity	1.0 litre
Oil Type	SAE 30 engine oil
Oil Sump Capacity	0.55 litres

* A minimum of 87 octane / 87 AKI (91 RON).

* Fuel with up to 10% ethanol is acceptable.

* Do not use unapproved fuels, such as E15 and E85

SETUP

IMPORTANT: Remove and discard the protective plastic sheet that covers the engine and any other plastic or wrapping on the mower.

Delivery Checklist

Check that the following items have been supplied correctly.

1. Engine Handbook
2. Grass bag Assembly
3. Parts List
4. Declaration of Conformity

If any items are missing, contact your supplying Hayter dealer.

To prevent accidents cut off the long ribbon attached to the grass bag and discard.
(Refer fig.1)

Assembling and Unfolding the Handle

WARNING: Assembling and unfolding the handle improperly can damage the cables, causing an unsafe operating condition.

- Do not damage the cables when assembling and unfolding the handle.
- Ensure that the cables are routed inside of the handle.
- If a cable is damaged, contact a Hayter Authorised Service Dealer.

Unscrew the securing hand bolts sufficiently to allow the handle to pivot. Hold the engine stop lever in towards the handle and unfold the handle to the operating position, then release.
Tighten both hand bolts to secure in position.
(Refer fig.2)

Grass Bag Assembly

Before first use, assemble the grass bag and frame. Slide the frame (1) into the grass bag (2), ensuring that the handle is above the grass bag as shown. Attach plastic clips (A) to the grass bag frame.
(Refer fig.3)

Raise the rear deflector, lower the grass bag and hook into position. Lower the deflector to rest on the grass bag.

Prevent Engine Damage

To prevent engine damage the engine is shipped without oil or fuel. The engine must be filled with the correct grade of oil and fuel before starting the engine.

Fig. 1



Fig. 2

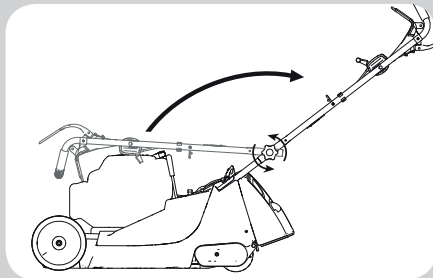
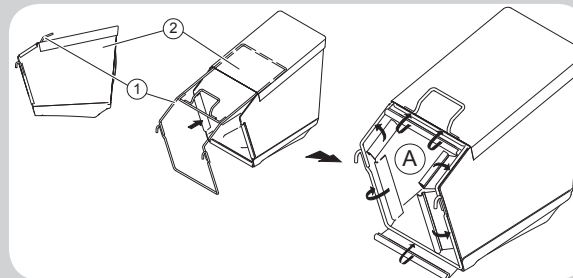

Fig. 3



SETUP

Engine Detail

NOTE: Disconnect the spark plug lead before performing any maintenance procedures.

WARNING: Improper maintenance, use of non-conforming replacement components, or the removal or modification of the engine may cause serious injury or death.

(Refer to fig 4)

Filling the Engine with Oil

IMPORTANT: Your mower does not come with oil in the engine. Before starting the engine, fill the engine with oil.

1. Move the mower to a level surface.
2. Remove the dipstick by rotating the cap counterclockwise and pulling it out.
3. Carefully pour about 3/4 of the engine capacity of oil into the oil-fill tube.
4. Wait about 3 minutes for the oil to settle in the engine.
5. Wipe the dipstick clean with a clean cloth.
6. Insert the dipstick into the oil-fill tube, then

remove the dipstick.

7. Read the oil level on the dipstick.
 - If the oil level on the dipstick is too low, carefully pour a small amount of oil into the oil-fill tube, wait 3 minutes, and repeat steps 3 through to 5 until the oil on the dipstick is at the correct level.
 - If the oil level on the dipstick is too high, drain the excess oil until the oil on the dipstick is at the correct level; refer to Oil Service.

(Refer fig.5)

8. Install the dipstick securely.

IMPORTANT: If the oil level in the engine is too low or too high and you run the engine, you may damage the engine.

Engine Oil Specifications

Engine Oil Capacity	0.55 L (18.6 fl oz)
Oil viscosity	SAE 30 or SAE 10W-30 detergent oil
API service classification	SJ or higher

Fig. 4

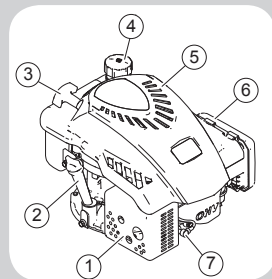

1.	Exhaust Guard
2.	Oil Filler & Dipstick
3.	Engine Start Cord
4.	Fuel Tank & Filler Cap
5.	Engine Cover
6.	Air Filter
7.	Spark Plug & Lead

Fig. 5

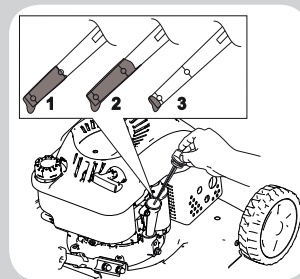

1.	Full
2.	High
3.	Low

BEFORE OPERATION

Fuel Type & Filling the Tank

For best results, use only clean, fresh, unleaded fuel with an octane rating of 87 or higher ((R+M)/2 rating method).

ETHANOL: Fuel with up to 10% ethanol (gasohol) or 15% MTBE (methyl tertiary butyl ether) by volume is acceptable. Ethanol and MTBE are not the same. Fuel with 15% ethanol (E15) by volume is not approved for use.

Never use fuel that contains more than 10% ethanol by volume, such as E15 (contains 15% ethanol), E20 (contains 20% ethanol), or E85 (contains up to 85% ethanol). Using unapproved fuel may cause performance problems and/or engine damage. Using unapproved fuel is not covered under the product warranty.

- Do not use fuel containing methanol.
- Do not store fuel either in the fuel tank or in fuel containers over the winter unless fuel stabiliser has been added to the fuel.
- Do not add oil to fuel.

IMPORTANT: To reduce starting problems, add fuel

stabiliser to the fuel all season, mixing it with fuel less than 30 days old.

Fill approximately to 1 inch below the base of neck, to allow for fuel expansion. Do not overfill the fuel tank. (Refer fig.6)

Fuel stabiliser and engine oil are both available to purchase from your Authorised Hayter Service Dealer. 111-9367 - Lawnmower Oil SAE 30 Hayter 111-9368 - Premium Fuel Treatment Hayter

Checking the Engine-Oil Level

Refer to Setup - Engine Oil Specifications to ensure you are using the correct grade of oil.

1. Move the mower to a level surface.
 2. Remove the dipstick by rotating the cap counterclockwise and pulling it out.
 3. Wipe the dipstick clean with a clean cloth.
 4. Insert the dipstick into the oil-fill tube, then remove the dipstick.
 5. Read the oil level on the dipstick.
- If the oil level on the dipstick is too low, slowly pour a small amount of oil into the oil-fill tube, wait

3 minutes, and then repeat steps 3 through 5 until the oil on the dipstick is at the correct level.

- If the oil on the dipstick is too high, drain the excess oil until the oil on the dipstick is at the correct level. To drain excess oil, refer to Changing the Engine Oil.

IMPORTANT: If the oil level in the engine is too low or too high and you run the engine, you may damage the engine.

6. Install the dipstick into the oil-fill tube securely. (Refer fig.7)

Fig. 6

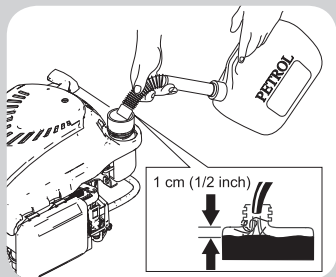
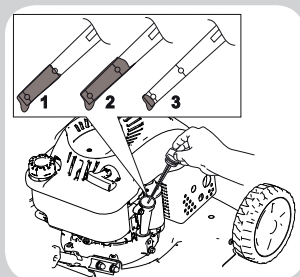

Fig. 7



1.	Full
2.	High
3.	Low

BEFORE OPERATION

Adjusting the Cutting Height

WARNING: Adjusting the cutting height may bring you into contact with the moving blade, causing serious injury.

- Shut off the engine and wait for all moving parts to stop.
- Do not put your fingers under the deck housing when adjusting the cutting height.

There are 7 cutting-height settings from 13 to 60mm.

To change the cutting height, hold the lever and pull it sideways to disengage it from the locking notch.

- Pull the lever backwards to raise the cutting height
- Push the lever forwards to lower the cutting height.

Finally release the lever at the required position and ensure it locks firmly into one of the setting notches. Always select a cutting height to suit the operating conditions. Prevent engine overload and blockages by avoiding low cuts in long grass. Be prepared to make two cuts when the grass is long. (Refer fig.8)

Non Grassed Areas

When moving the mower across non-grassed areas, stop the engine and set the mower to the maximum height of cut to protect the cutting mechanism. (Refer fig.8)

Controls

WARNING: Improper maintenance, use of non-conforming replacement components, or the removal or modification of the control cable(s) may cause serious injury or death.

IMPORTANT: To avoid damage to the cable, the variable speed control should only be operated whilst the engine is running.

Operate all control levers several times and ensure that the cables move freely. Check that the engine stop and ground drive clutch levers return freely to their rest position when released. (Refer fig.9)

Before Mowing

To prevent accidents, thoroughly inspect the area and remove all objects which when contacted by the

mower blade could become dangerous projectiles. Inspect the area for hidden obstructions which when contacted by the blade could risk health and safety or result in damage to the mower.

Remember the location of these obstructions and ensure that you mow around them. (Refer fig.10)

Fig. 8

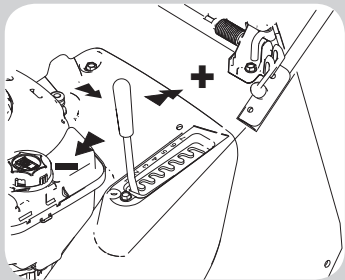

Fig. 9

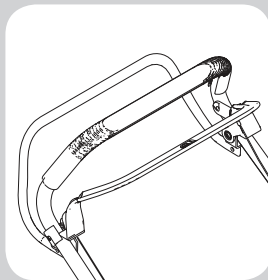
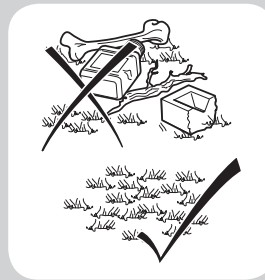

Fig. 10



DURING OPERATION

Starting

To prevent engine damage do not operate the engine start cord when the engine is running. If the engine does not start after repeated attempts, contact your local Hayter Authorised Service Dealer.

Firmly hold the engine stop lever against the handle. Pull the engine start cord handle lightly until you feel resistance, then pull sharply. (Refer fig.11A)

When the engine starts, slowly return the cord to the storage position. If the engine stop lever is released, the engine will stop. (Refer fig.11B)

Forward Travel

Firmly hold the engine stop lever against the handle. Move the ground drive clutch lever toward the handle (A) and hold it in position to power the mower forward.

Adjust the ground speed by operating the variable speed control (B). Push forward to speed up and pull back to slow down. (Refer fig.12)

Shutting off the Engine

IMPORTANT: When you release the engine stop and the ground drive clutch levers, the engine should shut off and the blade should stop within 3 seconds. If they do not, stop using your mower immediately and contact a Hayter Authorised Service Dealer.

To shut off the engine, release the engine stop lever (1) and ground drive clutch lever (2). (Refer fig.13)

Emergency stop: As above. If the engine fails to stop, disconnect the spark plug lead (3). (Refer fig.13)

Parking

Park on level ground.

Turning

To prevent accidents do not raise the front of the mower excessively when making a turn. Never raise the rear of the mower when the engine is running.

To make a wide turn, steer the mower with the handle in the direction required.

To make a tight turn release the ground drive clutch lever, apply downward pressure on the handle to raise the front wheels just above ground level and steer in the required direction.

Trim Side Cutting

Incorporation of a Trim Side allows you to cut right to the edge. This is ideal for mowing around borders, raised flower beds and retaining walls. (Refer fig.14)

Fig. 11

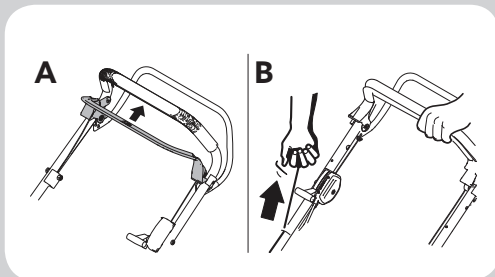

Fig. 12

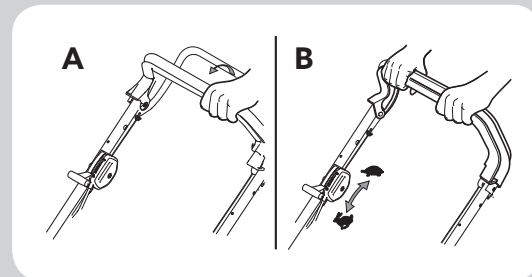

Fig. 13

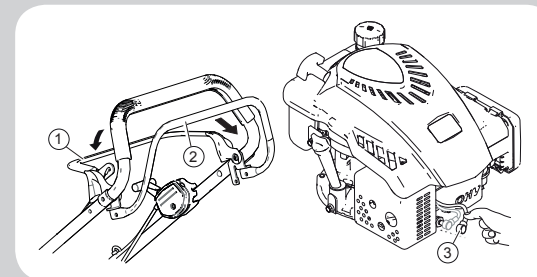
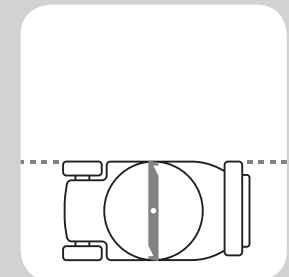

Fig. 14



DURING OPERATION

Vari-Pitch™ Cutting Technology

Vari-Pitch™ cutting technology automatically adjusts the cutter deck height at the rear of the mower, to increase air flow when cutting longer grass.

(Refer fig.15)

Heavy Growth

Areas of heavy growth should be mown without collecting the clippings. Refer to Mowing without the grass bag.

If collection is required, first mow the area without the grass bag, at the maximum height of cut setting. Allow the grass clippings to dry out and then mow the area at the maximum height of cut setting with the grass bag fitted. Refer to Adjusting the Cutting Height.

Reduce the height of cut and mow the area again as necessary until the required finish is obtained.

To prevent damage to your lawn do not remove more than one third of grass height in one cut.

(Refer fig.16)

Grass Bag

Attaching the grass bag:

1. Raise and hold up the rear deflector (1)
2. Hook the grass bag into position (2).
3. Lower the rear deflector.

(Refer fig.17)

When collecting grass clippings it is important that the grass bag is emptied regularly to prevent blockages and engine overloading.

Good grass collection depends on good air flow through the grass bag. To empty the grass bag, pour out the grass clippings and shake the grass bag vigorously to clean the airways.

(Refer fig.18)

Mowing without the Grass Bag

Remove the grass bag and operate the mower with the rear deflector in the closed position.

(Refer fig.19)

Friction Disc

The blade is driven by the engine via a friction disc to help prevent damage occurring to the engine crankshaft and cutting mechanism when a hidden obstruction or overload is encountered.

(Refer fig.20)

Always stop the engine when a hidden obstruction or excessive vibration is encountered.

Disconnect the spark plug lead and examine the cutting mechanism.

ALWAYS replace a damaged blade. Consult your Authorised Hayter Service Dealer.

Fig. 15

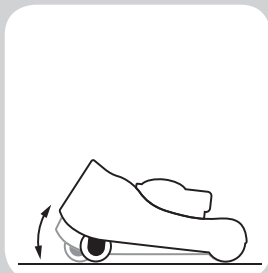

Fig. 16

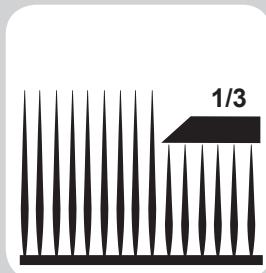

Fig. 17



Fig. 18

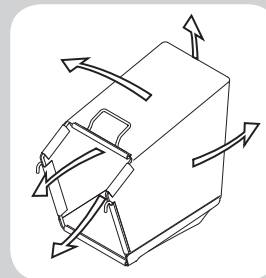

Fig. 19

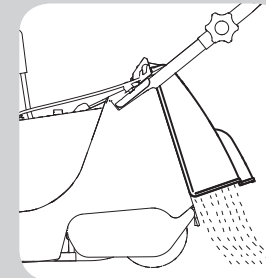
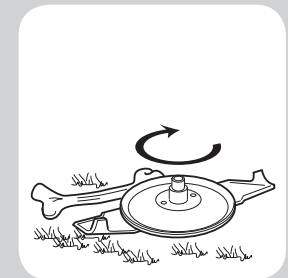

Fig. 20



AFTER OPERATION

Cleaning the Mower

WARNING: Improper maintenance, use of non conforming replacement components, or the removal or modification of the deck may cause death or serious injury.

WARNING: This mower may dislodge material from under the mower.

- **Wear eye protection**
- **Stay in the operating position (behind the handle) when the engine is running.**
- **Do not allow bystanders in the area.**

For best results clean the mower as soon as you have completed mowing.

1. Move the mower onto a flat surface.
2. Shut off the engine and wait for all moving parts to stop before leaving the operating position.
3. Lower the mower to its lowest cutting height setting; refer to Adjusting the Cutting Height.
4. Wash out the area under the rear deflector where the grass clippings go from the the housing to the grass bag.

5. Attach a garden hose, that is already connected to a water supply to the easy wash port.

(Refer fig.21)

6. Turn the water on.
7. Start the engine and run it until no more clippings come out from under the mower.
8. Shut off the engine.
9. Shut off the water and disconnect the garden hose from the mower.
10. Start the engine and run it for a few minutes to dry the underside of the mower.
11. Allow the engine to cool before storing the mower in an enclosed area.

Folding the Handle

WARNING: Folding or unfolding the handle improperly can damage the cables, causing an unsafe operating condition.

IMPORTANT: Route the cables inside of the handle as you fold the upper handle.

1. Loosen the two handle securing hand bolts.

2. Fold the handle by rotating it forward.
(Refer fig.22)

If a cable is damaged, contact a Hayter Authorised Service Dealer.

Fig. 21

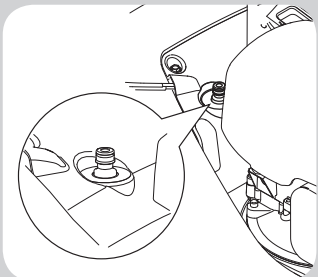
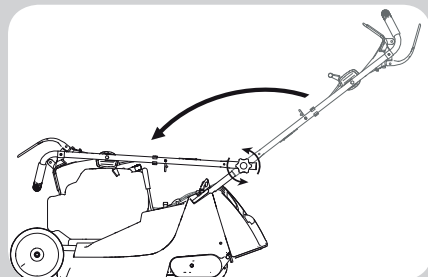

Fig. 22



MAINTENANCE SCHEDULE

Note: Determine the left and right sides of the mower from the normal operating position.

Recommended Maintenance Schedule

Maintenance Service Interval	Maintenance Procedure
Before each use or daily	<ul style="list-style-type: none">- Check the engine-oil level.- Clean grass clippings and dirt from under the mower.- Check the condition of guards and safety devices.- Check the condition of the blade.- Check condition of grass bag and ensure airways are clear (replace if damaged).
After very first 5 hours	<ul style="list-style-type: none">- Change the engine oil.
Every 25 hours	<ul style="list-style-type: none">- Change the engine oil if continuously operating under heavy load or high ambient temperature.- Service the air filter.- Grease the inner control cables at point of entry and exit from their outer casing.- Check the clutch cable adjustment.- Sharpen the blade.
Every 50 hours	<ul style="list-style-type: none">- Change the engine oil- Clean the air filter.
Every 100 hours	<ul style="list-style-type: none">- Replace the spark plug.
Yearly	<ul style="list-style-type: none">- Replace the air filter; replace it more frequently in dusty operating conditions.- Replace the blade or have it sharpened (more frequently if the edge dulls quickly).- Clean the air-cooling system; clean it more frequently in dusty operating conditions.- Change the engine oil.
Yearly or before storage	<ul style="list-style-type: none">- Lubricate wheels, pivot points and linkages.- Empty the fuel tank before repairs as directed and before yearly storage.

Failure to follow this maintenance schedule could result in non warrantable failures.

MAINTENANCE

Preparing for Maintenance

IMPORTANT: Before tipping the mower to change the oil or replace the blade, allow the fuel tank to run dry through normal usage. If you must tip the mower prior to running out of fuel, use a hand fuel pump to remove the fuel. Always tip the mower onto its side, with the dipstick down.

WARNING: Tipping the mower may cause the fuel to leak. Fuel is flammable and explosive and can cause personal injury.

1. Shut off the engine and wait for all moving parts to stop.
2. Disconnect the spark plug wire from the spark plug.
3. After performing the maintenance procedure (s), connect the spark plug wire to the spark plug.

Air Filter Service

WARNING: Never start and run the engine with the air filter removed.

NOTE: Do not use pressurised air or solvents to clean the filter. Pressurised air can damage the filter and

solvents will dissolve the filter.

1. Press down on the latch tabs, on top of the air-filter cover.
2. Open the cover (1).
3. Remove the paper air filter (2) and the foam pre-filter (3).
4. Inspect the foam pre-filter, and replace it if it is damaged or excessively dirty.
5. Inspect the paper air filter.
 - If the air filter is damaged or is wet with oil or fuel, replace it.
 - If the air filter is dirty, tap it on a hard surface several times.

NOTE: Do not brush the dirt off the filter; brushing forces dirt into the fibers.

6. Remove the dirt from the air-filter body and the cover, using a moist rag.

IMPORTANT: Do not wipe dirt into the air duct.

7. Install the paper air filter (2) and the foam pre-filter (3) into the air filter.

8. Install the cover (1).
(Refer to fig.23)

Fig. 23

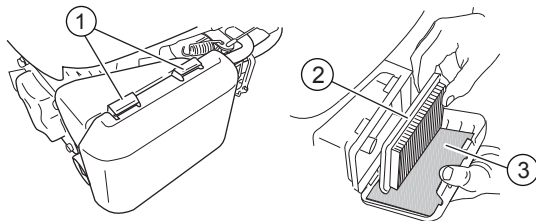

MAINTENANCE

Changing the Engine Oil

NOTE: Run the engine a few minutes to warm the oil before changing it. Warm oil flows better and carries more contaminants.

Refer to Setup - Engine Oil Specifications to ensure you are using the correct grade of oil.

1. Move the mower to a level surface.
2. Shut off the engine and wait for all moving parts to stop.
3. Disconnect the spark plug wire from the spark plug.
4. Remove the dipstick by rotating the cap counterclockwise and pulling it out.
5. Tip the mower onto its side (so that the air filter is up) to drain the used oil from the oil-fill tube.
6. After draining the used oil, return the mower to the operating position.
7. Carefully pour about 3/4 of the engine capacity of oil into the oil-fill tube.
8. Wait 3 minutes for the oil to settle in the engine.
9. Wipe the dipstick clean with a clean cloth.

10. Insert the dipstick into the oil-fill tube, but do not screw it in, then remove the dipstick.
11. Read the oil level on the dipstick. Refer to Checking the Engine-Oil Level.
 - If the oil level on the dipstick is too low, carefully pour a small amount of oil into the oil-fill tube, wait 3 minutes, and repeat steps 8 through 10 until the oil level on the dipstick is correct.
 - If the oil level on the dipstick is too high, drain the excess oil until the oil level on the dipstick is correct.

(Refer to fig.24)

IMPORTANT: If the oil level in the engine is too low or too high and you run the engine, you may damage the engine.

12. Return the dipstick into the oil-fill tube and tighten.
13. Recycle the used oil according to local authority guidelines.
14. After performing the maintenance procedure (s), connect the spark plug wire to the spark plug.

Servicing the Spark Plug

Improper maintenance, use of non conforming replacement components, or the modification of the spark plug may cause death or serious injury.

Use a Champion RN9YC spark plug or equivalent.

1. Shut off the engine and wait for all moving parts to stop.
2. Disconnect the wire from the spark plug.
3. Clean around the spark plug.
4. Remove the spark plug from the engine.

IMPORTANT: Replace a cracked, fouled, or dirty spark plug. Do not clean the electrodes because grit entering the engine can damage the engine.

5. Check the spark plug gap (1 & 2) with a gauge (3). Set the gap on the plug to 0.76mm with a lead gauge (3). Install and tighten the spark plug, torque to 180 lb-in (20 Nm).

(Refer to fig.25)

Fig. 24

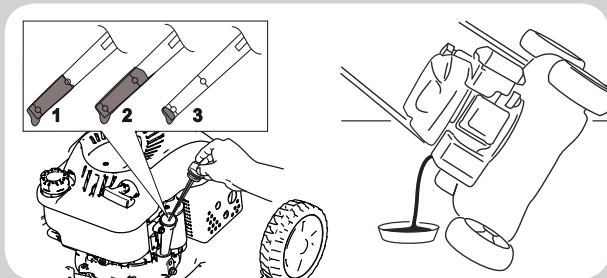
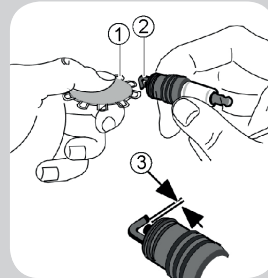

Fig. 25



MAINTENANCE

Remove & Replace the Blade

IMPORTANT: You will need a torque wrench to replace the blade properly. If you are uncomfortable performing this procedure or do not have a torque wrench, contact a Hayter Authorised Service Dealer.

WARNING: The blade is sharp; contacting the blade can result in serious personal injury. Wear gloves when servicing the blade.

Examine the blade regularly. If the blade is damaged or cracked, replace it immediately. If the blade edge is dull or nicked, have it sharpened and balanced, or replace it.

1. Refer to Preparing for Maintenance.
2. Tip the mower onto its side with the dipstick down.
3. Use a block of wood to hold the blade steady.
4. Remove the blade, saving all mounting hardware.

(Refer fig. 26)

5. Install the new blade (4) with the edges turned up, facing towards the mower housing. Secure the cutterblade (4) using the bolt (1), spring washer (2) and distance piece (3).

6. Tighten the blade bolt to the specified torque of 54 Nm. The blade will curve slightly when tightened against the friction disc.

(Refer fig. 27)

Blade Sharpening

A slightly worn blade may be re-sharpened. Both blade edges must be sharpened equally to ensure balance. Sharpen the blade every 25 mowing hours or more frequently if conditions require.

Remove the blade from the mower and clean using a brush and water. Inspect the blade for signs of damage. Sharpen both cutting edges with a flat file to restore performance.

(Refer fig. 28)

Ensure that the blade is balanced. Use a screwdriver with a round shaft to support the blade through its centre hole. Hold the blade horizontal and then release. A balanced blade will remain horizontal.

(Refer fig. 29)

If the blade is not balanced the heavy end will rotate downwards. Sharpen the heavy end until the blade is correctly balanced.

(Refer fig. 30)

Fig. 26

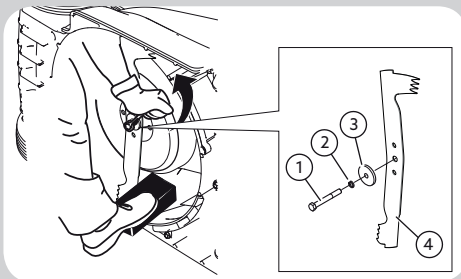

Fig. 27

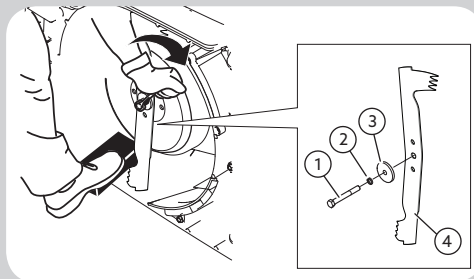

Fig. 28

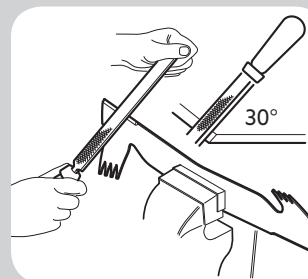

Fig. 29

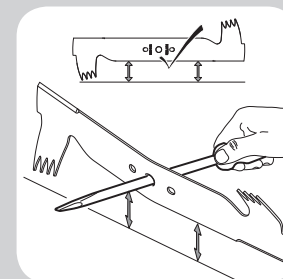
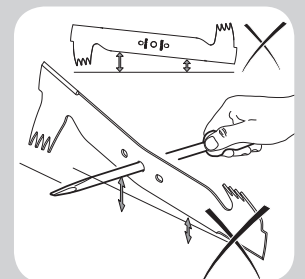

Fig. 30



MAINTENANCE

Clutch Cable Adjustment

At any time the operator feels that the mower is losing drive, check the following.

- Stop the engine.
- Pull the mower backwards at the same time progressively engage the clutch lever until the rear rollers lock, at this point the clutch lever should be 60 mm from the handle.
- If the distance between the clutch lever and handle is less than 60 mm regulate the engagement position using the black plastic cable adjuster (1) to regain the 60 mm distance.

Note this adjustment is approximate, at the nearest opportunity, a service should be carried out to ensure the spring on the clutch cable attached to gearbox is correctly set. This adjustment should be done using the black plastic cable adjuster (1).

(Refer fig.31)

With the clutch lever fully engaged, the cable should be adjusted to give a spring extension of 10 mm.

(Refer figs. 32 & 33)

Securing Nuts & Bolts

Regularly check that all securing nuts and bolts are tight. Replace missing or damaged items immediately.

Rear Deflector

WARNING: Improper maintenance, use of non conforming replacement components, or the removal or modification of the rear deflector may cause death or serious injury.

Remove grass debris from the rear deflector immediately after use and check its condition for signs of damage.

Carburetor Adjustments

Never make adjustments to the carburetor or engine speed. The carburetor was set at the factory to operate efficiently under most conditions.

Do not tamper with the governor spring, linkages, or other parts to change the engine speed detailed in the Product Specification section. If any adjustments are required contact your Hayter Authorised Service Dealer for service.

Blade Brake Test

The engine and blade are designed to stop within 3 seconds, after you release the engine stop lever. Ensure that the engine stop lever functions properly each time before you operate the mower.

If the blade does not stop within 3 seconds or there is a grinding or scraping, metal-to-metal noise when you release the engine stop lever, contact a Hayter Authorised Service Dealer.

This same recommendation applies if you observe heavy vibrations when using the mower.

Lubrication

Lubricate the wheel bearings, pivot points and linkages with engine oil yearly or before storing mower away.

Apply a good quality medium grease to the inner control cables at the point of entry and exit from their outer casing.

Do not add lubricant or grease to the polymer rear roller bearings.

Fig. 31

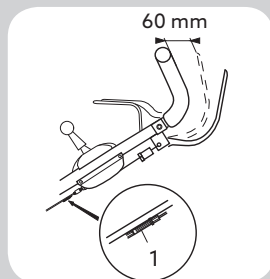

Fig. 32

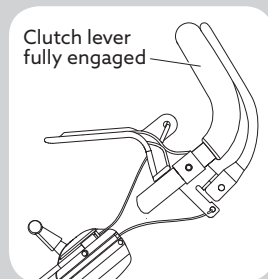
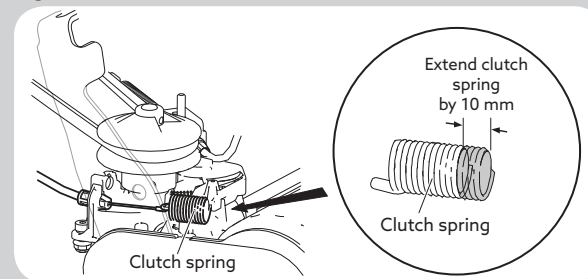

Fig. 33



STORAGE

Storage Safety

Always shut off the mower, wait for all moving parts to stop, and allow the mower to cool before adjusting, servicing, cleaning, or storing it.

Preparing the Mower for Storage

- Clean grass clippings and dirt from under the mower.
- On the last refueling of the year, add fuel stabiliser to the fuel as directed on the label.
- Dispose of any unused fuel properly. Recycle it according to local authority guidelines.

IMPORTANT: Old fuel in the fuel tank is the leading cause of hard starting. Do not store the fuel without fuel stabiliser more than 30 days, and do not store stabilised fuel beyond the duration recommended by the fuel-stabiliser manufacturer.

- Run the mower until the engine shuts off.
- Start the engine again and allow it to run until it shuts off. When you can no longer start the engine, it is sufficiently dry.
- Disconnect the wire from the spark plug.

- Remove the spark plug, add 30 ml (1 fl oz) of engine oil through the spark-plug hole, and pull the engine start cord slowly several times to distribute oil throughout the cylinder to prevent cylinder corrosion during the off-season.
- Loosely install the spark plug.
- Tighten all nuts, bolts, and screws.
- Lubricate the mower and treat metal parts with a water repellent anti-corrosion product.
- Cover the mower with a protective sheet and store it in a dry, ventilated area.

Storage

When storing your mower away, ensure that cables do not become snagged at the pivot points. Disengage the engine stop lever to prevent it being damaged through potential contact with the engine.

To store the handle, unscrew the two securing hand bolts sufficiently, to allow it to be pivoted forwards to rest against the mower.

(Refer fig.34)

Removing the Mower from Storage

- Check and tighten all fasteners.
- Remove the spark plug and spin the engine rapidly by pulling the engine start handle to blow the excess oil from the cylinder.
- Install the spark plug and tighten it with a torque wrench to 20 N·m (15 ft-lb).
- Perform any maintenance procedures; refer to Maintenance.
- Check the engine-oil level; refer to Checking the Engine-Oil Level.
- Fill the fuel tank with fresh fuel; refer to Filling the Fuel Tank.
- Connect the wire to the spark plug.

Fig. 34

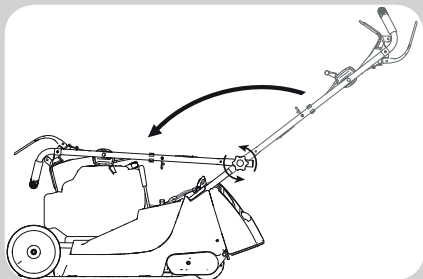

TROUBLE SHOOTING

PROBLEM	CAUSES	CORRECTIVE ACTION
Engine will not turn over	Engine stop lever released	Operate engine stop lever
	Incorrect oil level	Check oil level
	Obstruction under deck	Remove obstruction
Engine smokes	Excess oil	Check oil level
	Air filter cartridge oil soaked or blocked	Service air filter
Engine runs then stops	Fuel starvation	Fill fuel tank
	Fuel cap vent blocked	Clean fuel cap vent
Engine will not start	Engine under load	Raise the height of cut
	Incorrect / contaminated fuel	Drain tank and fill with correct fuel
	Spark plug lead disconnected	Connect spark plug lead
	Engine brake not released	Operate engine brake lever
	Faulty spark plug	Clean and adjust the gap or replace
	Wiring fault	Check wiring
Engine runs rough	Spark plug lead becoming disconnected in use	Connect spark plug lead
	Faulty spark plug	Clean and adjust gap or replace
	Air filter blocked	Service air filter
	Incorrect / contaminated fuel	Drain tank and fill with correct fuel
Engine vibrates excessively	Mounting bolt loose	Tighten bolt
	Blade bolt loose	Tighten bolt
	Blade out of balance	Balance blade
	Bent crankshaft	Consult your dealer

PROBLEM	CAUSES	CORRECTIVE ACTION
Uneven cut	Undulating ground conditions	Change direction of travel
	Blade worn	Sharpen blade
	Blade out of balance	Balance the blade
	Wheels/roller damaged	Inspect and replace as necessary
Discharge chute blocks	Grass is wet	Mow dry grass
	Cut height too low	Increase cut height
	Grass bag full	Empty grass bag
Mower is hard to push	No airflow through the grass bag	Clean the grass bag
	Cut height too low	Increase cut height
	Wheels/roller damaged	Inspect and replace as necessary
Mower will not self propel	Clutch out of adjustment	Adjust clutch cable
	Drive belt damaged	Replace drive belt
Poor grass condition	No airflow through the grass bag	Clean the grass bag
	Discharge chute blocked	Remove blockage
	Wet grass	Mow dry grass
Blade drive will not engage/disengage	Grass bag full	Empty grass bag
	Engine stop lever not fully forward	Push fully forward to disengage

WARRANTY

5 Year Warranty - Residential Use

90 Day Warranty - Commercial Use

Hayter Limited warrants to the original purchaser that this unit shall be free from defects in material and workmanship, under normal, residential use, for a period of five years from the date of purchase or, if used commercially, for a period of 90 days from the date of purchase. To qualify for the 5 year warranty, you must have the mower serviced annually by an Authorised Hayter Service Dealer* within 12, 24, 36 and 48 months of the date of purchase. Please note that these services will be charged at a rate agreed between you and the Dealer. If the mower is not serviced annually, the warranty will automatically expire twelve months after the mower's most recent annual service.

Excluded from warranty include those items which are subject to normal wear and tear, including but not limited to tyres, wheels, cutterblades, belts, cables, grass bags, batteries and other consumable wearing parts.

Lifetime Crankshaft Warranty

All Hayter branded mowers which are fitted with a genuine Hayter Friction Disc and Crank-Safe Blade Brake Clutch (integrated Blade Brake Clutch (BBC) + Friction Disc assembly) as original equipment and used by the original purchaser in accordance with recommended operating and maintenance procedures, are covered by a Lifetime Warranty against engine crankshaft bending. Mowers fitted with friction washers, Blade Brake Clutch (BBC) units and other such devices are not covered by the Lifetime Crankshaft Warranty.

Lifetime Deck Warranty

Hayter Limited warrants to the original purchaser that the mower deck, consisting of the die cast structure to which the engine is secured, will not crack or break during normal use for the lifetime of the product with the original purchaser. If such damage occurs Hayter Limited shall, at our option, repair or replace the mower deck at no cost. Deck failure due to misuse or abuse and corrosion occurring due to lack of regular maintenance are not covered. Mowers used commercially are excluded from this warranty.

Terms and Conditions

Hayter shall, at our option, repair or replace any part covered by warranty during the applicable period.

Your product must be registered within 14 days of purchase to qualify for the full benefit of the product warranty. Please go to www.hayter.co.uk/warranty-registration to complete this process.

This warranty does not apply to any unit that has been tampered with, altered, misused, abused or used for hire, and will become invalid if non-genuine Hayter parts are fitted. Minor mechanical adjustments are not covered unless they are due to defective material or workmanship. Consult the Owner's Handbook or a Hayter Authorised Service Dealer for assistance when making these adjustments.

Making a Claim

To make a warranty claim, return the unit to a Hayter Authorised Service Dealer, along with proof of purchase stating the mower serial number and date of purchase and the service receipt(s) or stamped service card.

This warranty gives you specific legal rights and are in addition to any statutory rights to which you may be entitled. Your statutory rights are not affected by this warranty. If you need additional information concerning this written warranty, or assistance in obtaining services please email customer.care@hayter.co.uk, write to Hayter Limited, Customer Care Team, Spellbrook, Bishop's Stortford, Hertfordshire CM23 4BU or Tel Freephone 0800 616 298 .

*Details of your local Hayter Authorised Dealer can be found on the Hayter website www.hayter.co.uk or contact: Freephone 0800 616 298.

EEA/UK Privacy Notice

Hayter's Use of Your Personal Information

Hayter Limited, and its parent, The Toro Company, respect your privacy. When you purchase our products, we may collect certain personal information about you, either directly from you or through your local retail outlet. We use this information to fulfil contractual obligations - such as to register your warranty, process your warranty claim or to contact you in the event of a product recall - and for legitimate business purposes - such as to gauge customer satisfaction, improve our products or provide you with product information which may be of interest. We may share your information with The Toro Company, its subsidiaries or affiliates, or with our dealers, retailers or other business partners in connection these activities. We may also disclose personal information when required by law or in connection with the sale, purchase or merger of a business. We will never sell your personal information to any other company for marketing purposes.

Retention of your Personal Information

We will keep your personal information as long as it is relevant for the above purposes and in accordance with legal requirements. For more information about applicable retention periods please contact legal@toro.com.

Hayter's Commitment to Security

Your personal information may be processed in the US or another country which may have less strict data protection laws than your country of residence. Whenever we transfer your information outside of your country of residence, we will take legally required steps to ensure that appropriate safeguards are in place to protect your information and to make sure it is treated securely.

Access and Correction

You may have the right to correct or review your personal data, or object to or restrict the processing of your data. To do so, please contact us by email at legal@toro.com. If you have concerns about the way in which Hayter Ltd. has handled your information, we encourage you to raise this directly with us. Please note that European residents have the right to complain to your Data Protection Authority.

Hayter Limited

Spellbrook,
Bishop's Stortford,
Herts
CM23 4BU
England

Customer Care Helpline: 0800 616 298

www.hayter.co.uk