

LawnMaster[®]

Instruction Manual

34cm 24V Lithium-Ion Cordless Mower CLMF2434G

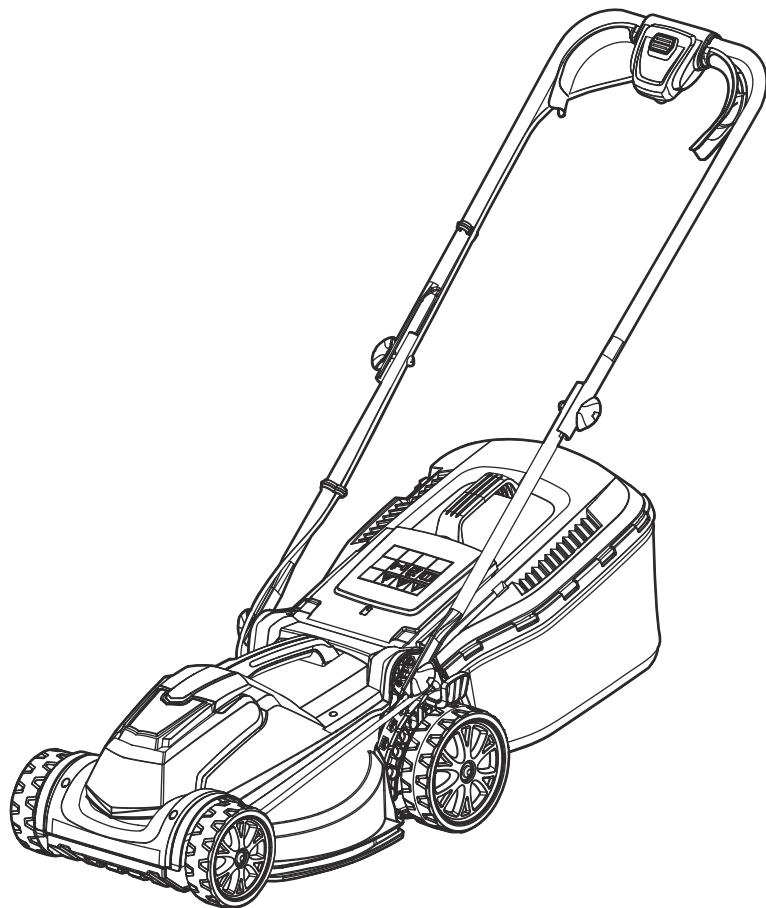

Original Instructions



WARNING: Read all safety instructions carefully before assembling and operating this machine. Ensure the machine has been assembled correctly and safely. Keep the instructions safe and pass them on to any subsequent user so that the information is always available.



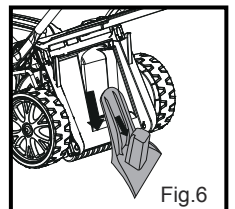
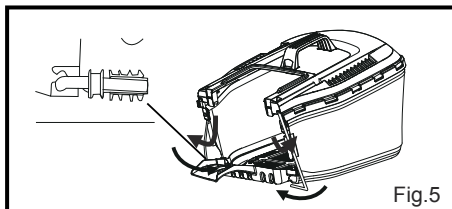
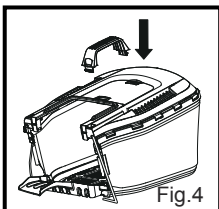
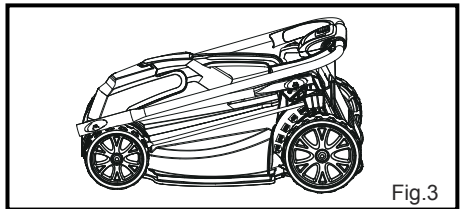
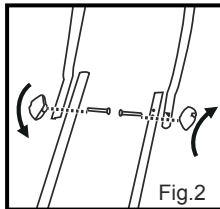
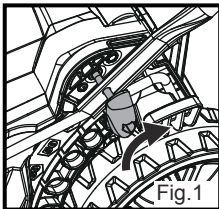
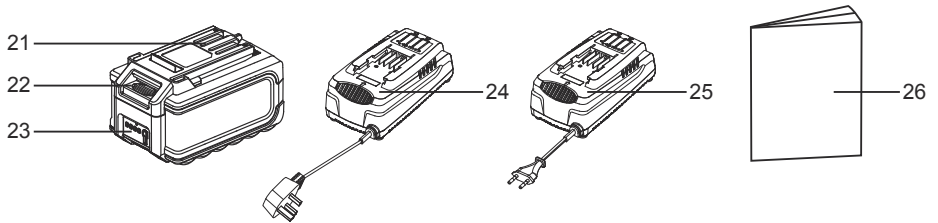
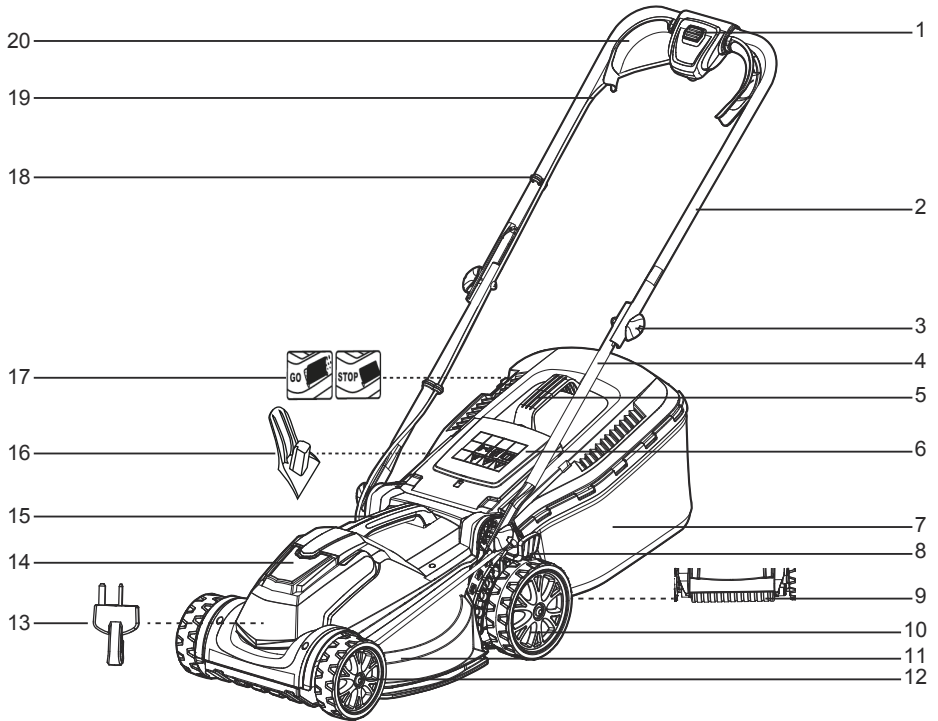



















TABLE OF CONTENTS



Section	Page
Symbols	6-7
Safety Information	8-17
In the Box	17
Assembly	18-20
Operation	21-25
Maintenance	26-28
Troubleshooting	29-30
Technical data	31
Recycling and Disposal	32

SYMBOLS

The following warning symbols appear throughout this manual and indicate the appropriate safety measures you should take when operating and maintaining the appliance.

SYMBOL	DESIGNATION/EXPLANATION
	Caution
	Read instruction manual.
	Keep bystanders away.
	Beware of sharp blades. Blades may continue to rotate after the motor is switched off. Beware of injury to toes or fingers.
	Switch off and remove the isolator key before adjusting, cleaning or before leaving the product unattended for any period.
	Wear eye and ear protection.
	Do not expose to rain.
	Wait until all moving parts have stopped completely before touching them. The blade may continue to rotate after the machine is switched off, a rotating blade can cause injury.
	WARNING! Beware of electric shocks.
	Cutting circle
	Protection class II (Double insulation)
	The product complies with the applicable European directives and an evaluation method of conformity for these directives was followed.
	Only recharge battery packs with the supplied charger indoors.
	Fuse
	Electrical appliances must not be disposed of with the domestic waste.
	Batteries contain Lithium-ion. Do not dispose of batteries in household waste.
	Do not dispose of battery packs in rivers or immerse in water.
	Do not dispose of battery packs in fire.

SYMBOLS

SYMBOL	DESIGNATION/EXPLANATION
	Do not subject the battery to direct sunlight over long periods and do not leave it on or near a heat source (max. 60°C).
	Recycle electrical waste products in an environmentally safe way where facilities exist.



WARNING

To avoid serious personal injury, do not attempt to use this product until you read thoroughly and understand completely the instruction manual.

If you do not understand the warnings and instructions in the instruction manual, do not use this product.

SAFETY INFORMATION



IMPORTANT

When using equipment, the following safety precautions must be followed to avoid injuries and damage:

- Read all operating instructions carefully and comply with them. It is important to understand these instructions and to acquaint yourself with the machine, its correct usage and all safety requirements.
- Keep this manual in a safe place so that the information is available to the operator at all times.
- If you give the equipment to any other person, give them these operating instructions as well.
- We accept no liability for damage or accidents which result from non-compliance with these instructions.

The device must not be used by people (including children) with limited physical, sensory or mental capabilities or who lack the necessary experience and/or knowledge - other than they are supervised by a person responsible for safety or are being instructed to operate the appliance by such a person. Children should be supervised to ensure that they do not play with the appliance.

- Read the instructions carefully. Be familiar with the controls and the correct use of the lawn mower.
- Never allow children or people unfamiliar with these instructions to use the mower. Local regulations may restrict the age of the operator.
- When not in use, store the mower out of reach of children

SAFETY INFORMATION

and remove the battery pack and isolator key.

- Never operate the machine while people, especially children, or pets are nearby.
- Use extreme care when approaching blind corners, doorways, shrubs, trees, or other objects that may obscure your view of a child or animal that may run into the path of the mower.
- Keep in mind that the operator or user is responsible for accidents or hazards occurring to other people or their property.
- While operating the mower always wear substantial footwear and long trousers. Do not operate the mower when barefoot or wearing open toed sandals. Avoid wearing clothing that is loose fitting or that has hanging cords or ties.
- Thoroughly inspect the area where the mower is to be used. Remove all stones, sticks, and other objects that could be tripped over or thrown by the blade. Thrown objects can cause serious personal injury.
- Before using, always visually inspect to see that the blade, blade bolt and the blade assembly are not worn or damaged. Replace worn or damaged components in sets to preserve balance. Replace damaged or unreadable labels.
- Operate the mower only in daylight or in good artificial light.
- Do not use the lawn mower in damp or wet conditions or operate in the rain.
- Working on sloping areas can be dangerous. Do not mow on excessively steep slopes. Always be sure of your footing on slopes or wet grass.

SAFETY INFORMATION

- Walk, never run.
- Mow across the face of slopes, never up and down.
- Exercise extreme caution when changing direction on slopes.
- Use extreme caution when reversing or pulling the mower towards you.
- Stay Alert: Do not operate the mower when you are tired. Pay attention to what you are doing.
- Do not operate the mower while under the influence of alcohol or drugs.
- Stop the blade(s) if the machine has to be tilted for transportation when crossing surfaces other than grass, and when transporting the machine to and from areas to be mowed.
- Never operate the mower with defective guards or shields, or without safety devices, for example deflectors and/or grass collector, in place.
- Switch on the motor carefully according to instructions and with feet well away from the blade(s).
- Do not tilt the machine when starting or switching the motor on, except if the machine must be tilted for starting in long grass. In this case, do not tilt it more than absolutely necessary and tilt only the part which is furthest away from the operator. Always ensure that both hands are in the operating position on the handle before returning the machine to the ground.
- Do not start the mower when standing in front of the discharge opening.
- Do not put hands or feet near or under rotating parts. Keep clear of the discharge opening at all times.

SAFETY INFORMATION

- Never pick up or carry the machine while the motor is running.
- Do not carry the machine with your finger on the switch.
- Do not overreach. Keep proper footing and balance at all times.
- Do not use a machine if the switch does not turn it on and off. Any machine that cannot be controlled with the switch is dangerous and must be repaired.
- In case any of the following situations occur, stop the mower and remove the battery pack and isolator key. Make sure that all moving parts have come to a complete stop:
 - Whenever you leave the mower,
 - Before clearing blockages or unclogging discharge chute,
 - Before checking, cleaning or working on the mower,
 - After striking a foreign object. Inspect the mower for damage and make repairs before restarting and operating the mower.
- If the mower starts to vibrate abnormally (check immediately)
 - Inspect for damage,
 - Replace or repair any damaged parts,
 - Check for and tighten any loose parts.
- In order to avoid contact with the blade or injury caused by a thrown object, ensure you maintain a safe operating distance, and keep children and bystanders at least 15m away from the mower while it is in operation. Stop the motor immediately if someone enters the mowing area.
- Always wear proper eye protection in order to protect your eyes while operating or performing any adjustment or repair. Thrown objects that ricochet can cause serious eye

SAFETY INFORMATION

injury.

- Do not hold on to the mower if you are falling. Release the handle immediately.
- Do not use the mower for any job except that for which it is intended. Do not force the mower.
- Do not attempt to adjust the wheels or the cutting height while the motor is running.
- Avoid dangerous environments. Do not operate the mower in the rain or in enclosed or poorly-ventilated environments, or if there are flammable or explosive fluids, vapours or gases nearby.
- Stop the blade when crossing gravel driveways, walkways, or roads.
- Keep all nuts, bolts and screws tight to be sure that the mower is in a safe condition for use.
- Check the grass collector frequently for wear or deterioration.
- Be careful during adjustment of the mower to prevent entrapment of the fingers between moving blades and fixed parts of the machine.
- Always allow the mower to cool down before storing.
- Stop the mower, remove the safety key and battery, and wait until the blade comes to a complete stop before removing the collection bag or carrying out maintenance. The cutting blade will continue to rotate for a few seconds after the motor is shut off. Do not place any part of your body in the blade area until you are sure that the blade has stopped rotating.
- Never operate mower without correct safety devices in place and in working order. Do not operate the mower with

SAFETY INFORMATION

damaged safety devices. Doing so can result in injury.

- Ensure that the isolator key is not installed when the mower is not in use. This prevents accidental starting of the machine.
- Replace worn or damaged parts for safety. Use only genuine replacement parts and accessories.
- Always be alert when using the machine, so that you can recognise and handle risks early. Fast intervention can prevent serious injury and damage to property.
- Switch off and remove the battery and isolator key if there is any malfunction. If necessary have the machine checked by a qualified specialist and repaired before you operate it again.
- **WARNING!** Even if you are operating the machine in accordance with all safety requirements, potential risks of injury and damage remain. The following dangers can arise in connection with the structure and design of this machine:
 - Health defects resulting from vibration emission if the machine is being used over long periods of time or not adequately managed and properly maintained.
 - Injuries and damage to property due to broken application tools or sudden impact of hidden objects during use.
- **WARNING!** This machine produces an electromagnetic field during operation! This field may under some circumstances interfere with active or passive medical implants! To reduce the risk of serious or fatal injury, we recommend persons with medical implants to consult their doctor and medical implant manufacturer before operating this product!
- Store the mower, the charger and the battery at a

SAFETY INFORMATION

temperature between 0°C and 25°C.

Battery Safety Information

- Recharge only with the charger specified by the manufacturer. A charger that is suitable for one type of battery pack may create a risk of fire when used with another battery pack. Incorrect use may result in electric shock, overheating or leakage of corrosive liquid from the battery.
- Do not place appliances or their batteries near fire or heat sources. Continuous intense sunlight, fire or other heat sources may cause an increased danger of explosion.
- Do not crush, drop or damage the battery pack. Do not use a battery pack or charger that has been dropped or received a sharp blow. A damaged battery is subject to explosion. Properly dispose of a dropped or damaged battery immediately.
- Batteries can explode in the presence of a source of ignition, such as a pilot light.
- To reduce the risk of serious personal injury, never use any cordless product in the presence of an open flame. An exploded battery can propel debris and chemicals. If exposed, flush with water immediately.
- Do not charge battery in a damp or wet location. Following this rule will reduce the risk of electric shock.
- For best results, your battery tool should be charged in a location where the temperature is more than 4°C but less than 40°C.
- Under extreme usage or temperature conditions, battery leakage may occur. If liquid comes in contact with your

SAFETY INFORMATION

skin, wash immediately with soap and water. If liquid gets into your eyes, flush them with clean water for at least 10 minutes, then seek immediate medical attention.

- When the battery pack is not in use, keep it away from other metal objects like: paper clips, coins, keys, nails, screws, or other small metal objects that can make a connection from one terminal to another. Shorting the battery terminals together may cause sparks, burns, or a fire.
- Do not open up the battery and avoid mechanical damage to the battery. Risk of short circuit and fumes may be emitted. Ensure fresh air and seek medical assistance in the event of discomfort.
- Always remove battery pack before storing the device. When battery becomes fully charged, unplug the charger from the power supply and remove the battery pack from the charger.
- Keep battery pack dry, clean, and free from oil and grease. Always use a dry cloth when cleaning. Never use brake fluids, gasoline, petroleum-based products, or any solvents to clean battery pack.

Charger Safety Information

- Ensure the battery pack is charged indoors only, in a dry, cool and well-ventilated environment.
- Do not use non-rechargeable batteries!
- Do not operate the charger with a damaged cord or plug, which could cause shorting and electric shock. If damaged, immediately discontinue use. Replace the charger with the identical unit as listed in the Product Specifications in this

SAFETY INFORMATION

manual. If the power cord for this equipment is damaged, it must be replaced by the manufacturer, a customer service agent of the same or a fully qualified person in order to prevent hazards.

- The plug of the charger must match the outlet. Never modify the plug in any way. Unmodified plugs and matching outlets will reduce the risk of electric shock.
- Allow a hot battery to cool before charging.
- Before each use, check the charger, cable and plug. Do not use a defective charger and do not disassemble the charger. Incorrect reassembly may result in the risk of fire, electric shock or electrocution.
- Protect the charger against moisture and wet conditions. There is a danger of electric shock.
- Operate the charger only with the appropriate original batteries. Charging other batteries may result in injuries and risk of fire.
- Keep the cord away from heat, oil, sharp edges or moving parts. Damaged or entangled cords increase the risk of electric shock.
- Do not use a charger that has been dropped or received a sharp blow.
- The voltage indicated on the charger rating plate must correspond to the voltage of the power source.
- Never touch the mains plug with wet hands.

Intended Use

This lawnmower is designed for domestic use only:

- This cordless lawnmower is intended for mowing lawns in domestic and hobby gardens.

SAFETY INFORMATION

- This product is not to be used in wet weather conditions and may not be used to mow wet or unusually high grass.
- This product is intended for private domestic use only, not for any commercial trade use. It must not be used for any purposes other than those described. Any use of the machine that deviates from its intended use will invalidate the warranty.

IN THE BOX

- | | |
|---|---|
| 1. Safety Switch Button | 15. Carry Handle |
| 2. Upper Handle | 16. Mulching Plug |
| 3. Wing Knob (x4) | 17. Grass Collection Full Indicator |
| 4. Lower Handle (x2) | 18. Cable Clip (x2) |
| 5. Grass Collection Bag Handle | 19. Power Cord |
| 6. Deflector Guard | 20. Start/Stop Switch Lever |
| 7. Grass Collection Bag | 21. Battery Pack (x2) |
| 8. Cutting Height Adjustment Lever | 22. Battery Release Button |
| 9. Rear Roller (included in UK products only) | 23. Battery Power Indicator |
| 10. Rear Wheel | 24. Battery Charger with BS plug (included in UK products only) |
| 11. Deck | 25. Battery Charger with VDE plug (included in mainland EU products only) |
| 12. Front Wheel | 26. Instruction Manual |
| 13. Isolator Key | |
| 14. Battery Compartment Cover | |

ASSEMBLY

Assembly Preparation

- Carefully remove all contents from the product packaging.
 - Ensure you have all the accessories and tool(s) needed for assembly and operation. This also includes suitable personal protective equipment.
-

WARNING

If any parts are damaged or missing do not operate this product until the parts are replaced. Failure to pay attention to this warning could result in serious personal injury.

WARNING

Do not attempt to modify this product or create accessories not recommended for use with this product. Any such alteration or modification is misuse and could result in a hazardous condition leading to possible serious personal injury.

WARNING

Do not connect the battery and/or the isolator key before the product is completely assembled. Failure to comply could result in accidental starting and possible serious personal injury.

WARNING

Never operate the mower without the proper safety devices in place and in working order. Never operate the mower with damaged safety devices. Failure to pay attention to this warning can result in serious personal injury. Make sure all packing is removed from product parts before starting assembly.

Assembling the Lower Handle (See Fig. 1)

- Unfold the lower handle. Place the lower handles into the slots in the deck.
- Rotate the 2 wing knobs clockwise to lock each lower handle into position (Fig. 1).

Assembling the Upper Handle (See Figs. 2-3)

- Fit the upper handle and lower handle together with the wing knobs on both sides of the handle assembly. Ensure the bolt and wing knob are assembled in the correct method. Failure to assemble the wing knob correctly can result in damage to the product (Fig. 2).
 - There are two possible height positions. Choose the one most suitable to the operator's height.
 - Secure the cable against the handle frame with the supplied cable clips.
 - When the two wing knobs are loosened, the handle can be folded for easy storage. Ensure the power cable is not caught between the folding sections (Fig. 3).
-

ASSEMBLY

Assembling the Grass Collection Bag (See Figs. 4-5)

Your mower comes with a tool free grass collection bag.

- Check the collection bag before assembling to make sure there is no damage.
- Insert the handle in the slots on the upper cover of grass collection bag. Ensure this securely 'clicks' into place (Fig. 4).
- Secure the metal support rods into the fixing position on either side of the grass collection base (Fig. 5). Ensure the side clamping sleeves are properly fixed onto the metal support frame.

Attaching/Removing the Grass Collection Bag (See Figs. 6-7)

NOTE: When using the grass collection bag, do not install the mulching plug. The mulching plug **MUST** be removed prior to installing the collection bag.

NOTE: The deflector guard is spring operated. Ensure you have a firm grip when opening and closing to avoid personal injury.

- Lift the deflector guard all the way up with one hand.
- Ensure the mulching plug is removed from the lawnmower before fitting the grass collection bag (Fig. 6).
- Lift the grass collection bag by its handle. Attach the grass collection bag onto the mounting brackets provided at the back of the lawn mower. Align the bottom of the grass collection bag first ensuring the collection tongue is located fully within the discharge chute of the lawnmower (Fig. 7).
- Lower the deflector guard onto the grass collection bag.
- To remove the grass collection bag, lift the deflector guard and unhook the grass collection bag from the mounting brackets. Carefully lower the deflector guard back down.

NOTE: Under normal usage, bag material is subject to wear. To reduce the risk of injury, frequently inspect the bag assembly and replace if there are any signs of wear or deterioration.

Grass Collection Full Indicator (See Figs. 8-9)

The grass collection full indicator is a small orange flap located on the side of the grass collection box.

- If the grass collection box is empty or it is not full with grass, the grass full indicator flap will remain open (Fig. 8).
- When this flap remains closed it means that the grass collection box is full and needs to be emptied (Fig. 9).

Attaching/Removing the Mulching Plug (See Figs. 10-11)



WARNING

Do not at any time make any adjustment to the lawnmower without first stopping the motor and removing the isolator key and battery.

ASSEMBLY

NOTE: The mulching plug **MUST** be removed if collection bag is used during mowing operation.

This mulching plug prevents grass from being collected by blocking the collection chute. This allows the grass clippings to be deposited back on the lawn during cutting. This finely cut grass acts as a nutrient for the lawn.

To install the mulching plug:

- Lift the deflector guard and detach the grass collection bag.
- Lift and hold the deflector guard up with one hand.
- With other hand grasp the mulching plug by its upright handle and insert the plug into the rear discharge chute. Ensure that the locking latch snaps into place (Fig. 10 & 11).
- Release the deflector guard back into position during operation.

To remove the mulching plug:

- Lift and hold the deflector guard up with one hand.
- With other hand squeeze the mulching plug's upright handle to release the locking latch. Pull the mulching plug up and out of the discharge chute.

Installing and Removing the Battery Pack (See Fig. 12)



WARNING

If any parts are broken or missing, do not attempt to attach the battery pack to the mower or operate the mower until the broken or missing parts are replaced. Failure to do so could result in serious injury. Do not connect the battery and/or the isolator key before the product is completely assembled. Ensure the isolator key is not fitted before you install the battery.

To install the battery pack:

- Lift the battery compartment cover on the lawnmower deck.
- Align the support rails located within the battery compartment with the guides in the battery pack, and then insert the battery pack into the compartment.
- Push the battery pack until you hear a “click”.
- Insert the isolator key into the keyholes located within the battery compartment.
- Close the battery compartment cover.

NOTE: Make sure that battery pack firmly snaps into place and is secured to the mower before starting operation.

To remove the battery pack:

- Stop the machine. Lift the battery compartment cover and remove the isolator key.
- Press the release button on the battery pack, grasp the battery pack firmly and pull out of the battery compartment (Fig. 12).
- Close the battery compartment cover.

OPERATION

WARNING

Do not allow familiarity with this type of product to make you careless. Always pay attention when operating this product, not doing so can result in serious injury.

WARNING

Always wear safety goggles or safety glasses with side shields when operating this product. Failure to do so could result in objects being thrown into your eyes, resulting in possible serious injury.

WARNING

Do not operate the appliance until the deflector guard and grass collection bag are fully installed.

Setting the Cutting Height (See Fig. 13)

WARNING

Switch off the equipment, disconnect the plug from the power supply and wait for the blade to come to a complete stop before adjusting the cutting height. A rotating blade can cause injury.

WARNING

Do not at any time make any adjustment to the lawn mower without first stopping the motor and removing the isolator key. Keep your feet away from the deck when adjusting its height.

Before using the mower for the first time, adjust the cutting position to the height best suited for your lawn.

The mower can be set to 6 cutting heights between 20mm and 70mm. Choose the appropriate cutting height according to the types and conditions of the grass.

CUTTING POSITION	CUTTING HEIGHT
1	20mm
2	30mm
3	40mm
4	50mm
5	60mm
6	70mm

OPERATION

To set the cutting height:

- To raise the cutting height, grasp the cutting height adjustment lever, disengage the lever from its current setting, and then move it towards the front of the mower and engage the lever in the desired cutting height position.
- To lower the cutting height, grasp the cutting height adjustment lever, disengage the lever from its current setting, and then move it towards the back of the mower and engage the lever in the desired cutting height position (Fig. 13).
 - For the first cut each season, a higher cutting setting should be selected. Using a cutting height that is too low in longer grass will use more power and reduce battery run time. It is recommended to cut longer grass in 2 passes or more. This method will also cause less stress to your grass for a healthier lawn.
 - Before you begin to mow, check to ensure that the blade is not blunt and that none of the fasteners are damaged. To prevent any imbalance, replace blunt and/or damaged blades. To carry out this check, first switch off the motor and remove the battery and isolator key.

Battery Pack Operation

■ Battery Charging



WARNING

Use only with 24V Lawnmaster® 24LFC12 battery charger.

The battery charger supplied is specifically designed for the lithium-ion battery used in this garden appliance and may cause risk of fire if used with a non-compatible battery pack.

Check the power voltage! Battery chargers operate on 220-240V AC.

Ensure the battery is charged between 4°C and 40°C. This ensures an optimum battery service life.

Protect the battery from heat, from continuous exposure to sun and keep away from radiation or other heat sources. Do not leave the battery in the mower in direct sunlight over long periods.

The battery is supplied partially charged. To ensure full capacity of the battery, charge the battery before using your appliance for the first time. The lithium-ion battery can be charged at any time without reducing its service life. Interrupting the charging procedure does not affect the battery.

■ Battery LED Indicators

The battery is equipped with a charge-level indicator panel which indicates its charge condition. This charge-level indicator panel consists of 4 LEDs on the battery. Press and hold the charge indicator button on the battery to actuate the charge level indicator. The charge level indicator LEDs go out after releasing the button. The battery charge level can be checked either when the battery is fitted on the machine or removed from the machine.

OPERATION

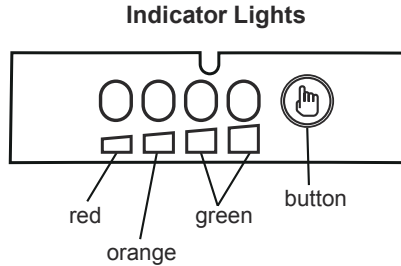

LED Indicators on Battery(Continuous lighting)	Battery Capacity
4 LEDs (inc 2 green)	Fully charged
3 LEDs (inc 1 green)	≥ 50%
2 LEDs (orange & red)	≥25%
1 LED (red only)	< 25%. Recharge required

Charger Operation (See Fig. 14)

WARNING

Use only with 24V Lawnmaster® 24LB4005 battery.







If any part of the charger is missing or damaged, do not operate it! Replace the charger with a new one. Failure to pay attention to this warning could result in possible serious injury.

Check the voltage! The voltage must comply with the information on the rating label.

- Align the slot of the battery pack with the rail on the charger. Slide the battery onto the rail until the battery pack secures into place (Fig. 14).
- Connect the charger to the power supply.
- Allow sufficient charging time (see Technical Data), and then disconnect the charger from the power supply.
- Press the release button on the battery pack and remove it from the charger.

NOTE: It is normal for the battery pack and the charger to become warm (but not hot) during charging process. If the battery does not charge properly, check to make sure the electrical outlet is operational. Always charge the battery before storage!

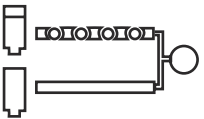
OPERATION

Battery Capacity	Battery Capacity	Battery Capacity	Battery Capacity
		Red, flashing	Charging paused, see instructions below.
		Red, continuous	Connected to power supply (Standby)
		Green, flashing	Charging
		Green, continuous	Fully charged

The intelligent charger measures the charge level of the battery pack and charges the battery accordingly with the required current and voltage, based on battery temperature and voltage, this ensures maximum battery life. Charge the battery fully before storage.

A flashing red LED light on the charger indicates that the battery temperature is not within the charging temperature range of 4°C - 40°C or the charging current is too high. As soon as the permitted temperature and the charging current ranges are reached, the battery charger will automatically switch to charging.

After continuous or repeated charging cycles without interruption, the charger may warm up. This is normal and does not indicate a technical defect of the battery charger.

Starting/Stopping the Mower (See Figs. 15-17)



WARNING

The blade may keep rotating for a few seconds after the device has been switched off. Do not touch the rotating blade. A rotating blade can cause injury.

- To switch on, insert the isolator key located within the battery compartment, press and hold the safety switch button and gently pull the start/stop switch lever towards the upper handle. Once started, release the safety button. (Fig. 15 - 17)
- To power off the mower, release the start/stop switch lever.
- Remove the isolator key if the mower is not going to be used immediately.

General Operation

Check the product and accessories for damage before each use. Before use, please ensure all

OPERATION

power connections are in good working order prior to installing the isolator key and battery. If damage is present or observed, please stop and have mower serviced before use. Do not use the product if it is damaged.

- Double check that the blade is properly installed.
- Always hold the product by its handles. Keep the handle dry to ensure safe support.
- Ensure that the air vents are always unobstructed and clear. Clean them if necessary with a soft brush. Blocked air vents may lead to overheating and damage the product.
- Switch the product off immediately if you are disturbed while working by other people entering the working area.
- Always let the product come to complete stop before removing the grass collection box.
- Do not overwork yourself. Take regular breaks to ensure you can concentrate on the work and have full control over the product.

Mowing (See Figs. 18-19)

- Make sure the lawn is clear of stones, sticks, wires, and other objects that could damage the lawn mower blades or motor. Such objects could be accidentally thrown by the mower in any direction and cause serious personal injury to the operator and others.
- When cutting longer grass, cut the grass in two or more passes by lowering the cutting height gradually at each pass. Never cut the grass by more than half its height.
- When cutting dense grass, reduce walking speed to allow for more effective cutting and a proper collection of the clippings.
- Do not cut wet grass as it can stick to the lawn mower and prevent the proper discharge of grass clippings.
- Clean the underside of the mower deck after each use to remove grass clippings, leaves, dirt, and any other accumulated debris.
- Watch for holes, ruts, rocks, hidden objects, or bumps which can cause you to slip or trip. Tall grass can hide obstacles. Remove all objects such as rocks, tree limbs, etc., which could be tripped over or thrown by the blade.
- Always be sure of your footing. A slip and fall can cause serious personal injury. If you feel you are losing your balance, release the start/stop switch lever immediately.
- Slopes are a major factor related to slip and fall accidents that can result in severe injury. Mowing on slopes requires extra caution. If you feel uneasy on a slope, do not mow it. For your safety, do not attempt to mow slopes greater than 15 degrees.
- Do not mow near drop-offs, ditches, or embankments; you could lose your footing or balance.
- We recommend that you mow in overlapping lines for effective grass collection. This will keep the rows even and ensures that all the lawn is cut without missing any spots (Fig. 18).
- The rear roller leaves a stripe finish on the lawn and helps to prevent scalping on borders and edges (Fig. 19).

NOTE: Rear roller only included in UK products.

MAINTENANCE



WARNING

Always switch the product off, disconnect the battery pack and isolator key and let the product cool down before performing inspection, maintenance and cleaning work!



WARNING

If a part becomes worn or damaged, use manufacturer recommended replacement parts. Use of any other parts may create a hazard or cause product damage.



WARNING

Do not use any attachments or accessories not recommended by the manufacturer of this product. The use of attachments or accessories not recommended can result in serious personal injury.

General Maintenance

- Keep all safety devices, air vents and the motor housing free of dirt and dust. Avoid using solvents when cleaning plastic parts. Most plastics are susceptible to damage from various types of commercial solvents and may be damaged by their use. Use clean, dry cloths to remove dirt, dust, oil, grease, etc.
 - Periodically check all nuts and bolts for proper tightness to ensure safe operation of the mower.
 - Remove any buildup of grass and leaves on or around the motor cover. Wipe the mower clean with a dry cloth occasionally. Do not use water.
-



WARNING

Always wear protective, heavy gloves and/or wrap the cutting edges of the blade with rags when performing blade maintenance. Failure to heed this warning could result in serious personal injury.



WARNING

Before performing any maintenance, make sure the isolator key and the battery have been removed. Failure to heed this warning could result in serious personal injury.

Replacing the Mower Blade (See Figs. 20-21)

NOTE: Remove the isolator key and battery before performing any maintenance!

NOTE: If the blade is blunt, damaged or showing signs of imbalance, it must be replaced. Use recommended replacement blades.

- Stop the motor and allow the blade to come to a complete stop.
 - With blade stopped, remove the ISOLATOR KEY and BATTERY from mower and store in a safe
-

MAINTENANCE

location.

- Remove the grass collection bag from mower if attached.
- Slowly turn the mower onto its side.
- Wedge a block of wood between the blade and the mower deck, or use safety gloves to firmly hold the blade, in order to prevent the blade from turning when the blade nut is being removed.
- Loosen the blade nut using a wrench or socket (not provided).
- Remove the blade nut anticlockwise, and then remove the blade (Fig. 20).
- Place the new blade on the drive shaft. Make sure it is installed with the curved ends pointing up towards the mower deck and not down towards the ground. Ensure that the blade is positioned correctly (Fig. 21).
- Torque the blade nut down using a torque wrench (not provided) to 25 Nm to ensure the bolt is properly tightened.

NOTE: Make certain all parts are replaced in the exact order in which they were removed.

Sharpening the Blade (See Fig. 22)

For best mowing performance, the mower blade must be kept sharp. A dull blade does not cut grass evenly and overloads the motor. If your lawn has sandy soil, more frequent sharpening may be required.

- Following the instructions in the “Replacing the Mower Blade” section to remove the mower blade. DO NOT attempt to sharpen the blade while it is attached to the mower.
- Using a fine-tooth file or sharpening stone, sharpen cutting edges on both ends of the blade, removing equal amounts of material from both ends (Fig. 22).



WARNING

When removing, inspect the blade carefully. If the blade is bent or damaged, replace immediately with a new blade. Failure to replace a bent or damaged blade could cause an accident resulting in possible serious injury.

Balancing the Blade (See Fig. 23)

When sharpening, care should be taken to keep the blade balanced. An unbalanced blade will cause excessive vibration when the mower is running. This vibration will eventually cause damage to the mower, especially the motor.

To check the blade balance:

- Clamp a screwdriver horizontally in a vise as shown.

NOTE: If a vise is not available, a straight nail can also be used.

- Place the centre hole of blade on the screwdriver (or nail) (Fig. 23).
 - If blade is balanced, it will remain in a horizontal position. If either end of the blade drops downward, sharpen the heavy side until the blade is balanced.
-

MAINTENANCE

Storing the Mower (See Fig. 24)

The device features the following storage options to save space:

- Before storing your mower, remove the isolator key and the battery.
- Loosen the wing knobs on both sides of the handle bars.
- Fold the upper handle and lower handles assembly over the device housing. Make sure that the cables do not become trapped (Fig. 24).
- Store the mower indoors in a cool, dry location out of the reach of children.
- Allow the motor to cool before storing the equipment in a confined space.

Battery and Charger Maintenance

- Keep the battery and charger clean and clear of debris. Do not allow foreign material into the recessed cavity or on the contacts. Wipe with a dry cloth. Do not use solvents, water, or place in wet conditions.
- Always unplug the charger when there is no battery pack in it.
- Check that the charger and battery contacts have not been shorted by debris or foreign material. Always store away from metal objects which could create a connection with the terminals.
- Always remove the battery when storing the mower and keep in a cool dry place out of direct sunlight.
- Store the battery only within a temperature range between 0°C and 25°C and do not subject or store the battery pack to direct sunlight.
- It is recommended to store the lithium-ion battery pack in a 30%-50% charged condition.
- It is recommended to fully charge the lithium-ion battery pack after every six months of storage.

TROUBLESHOOTING



WARNING

Only perform the steps described within these instructions! All further inspection, maintenance and repair work must be performed by a qualified specialist.

Gloves and appropriate protective clothing must be worn when performing these instructions.

Always turn off the machine and remove the battery pack and isolator key before making any adjustment.

PROBLEM	POSSIBLE CAUSE	SOLUTION
Mower fails to operate.	Possible clogging.	Check underneath the mower and clear as necessary (always wear gardening gloves).
	The battery is not fully charged.	Charge the battery.
	The battery is not inserted (properly).	Ensure the battery is correctly inserted.
	The grass is too long.	Increase the height of cut and tilt garden product to reduce the starting load.
	The battery is too hot/cold.	Allow the battery to cool/warm to room temperature.
	The isolator key is not inserted correctly/fully.	Fit the key correctly.
	There is a short delay in the motor starting after engaging the switch lever.	This is normal. Hold the switch lever for 1-3 secs to start the motor.
Motor starts and stops immediately.	The battery is not fully charged.	Charge the battery.
	The isolator key is not inserted correctly/fully.	Fit the key correctly.
	The battery is not inserted (properly).	Ensure the battery is correctly inserted.
	The battery is too hot/cold.	Allow the battery to cool/warm to room temperature.
Garden product functions intermittently.	Motor protector has activated.	Allow the motor to cool and increase the height of cut.
Lawnmower leaves ragged cut.	Height of cut is too low.	Increase the height of cut.
	Cutting blade is blunt.	Replace the blade.

TROUBLESHOOTING

Mower does not mulch properly.	Wet grass clippings are sticking to the underside of the deck.	Wait until the grass dries before mowing.
	Missing mulching plug.	Install the mulching plug.
Poor cutting or motor labours.	Possible clogging.	Check underneath the mower and clear out as necessary (always wear gardening gloves).
	The blade is fitted upside down.	Refit the blade correctly.
Area of cut (battery duration) is not large enough.	Height of cut is too low.	Increase the height of cut and walk slower.
	The grass is too high.	Increase the height of cut and walk slower.
	The grass is wet or damp.	Wait until the grass is dry and walk slower.
	The grass is dense.	Increase the height of cut, walk slower and cut more frequently.
The cutting blade is not rotating while the garden product is switched on.	The cutting blade is obstructed.	Switch off the garden product and clear obstruction (always wear gardening gloves).
	The blade nut/bolt is loose.	Tighten the blade nut/bolt (25 Nm).
Excessive vibrations/noise.	The blade nut/bolt is loose.	Tighten the blade nut/bolt (25 Nm).
	Cutting blade is damaged.	Replace the blade.
No charging procedure possible.	The battery contacts are contaminated.	Clean the battery contacts (e.g. by inserting and removing the battery several times) or replace the battery.
	Socket outlet, fuse, mains cable or battery charger are defective.	Check the mains voltage and fuse, if necessary, contact aftersales helpline.
	The battery has a fault.	Replace the battery.
The charge control LEDs do not light up after inserting the mains plug into the socket.	Mains plug of the battery charger is not plugged in (properly).	Insert mains plug (fully) into the socket outlet.
	Socket outlet, mains cable or battery charger are defective.	Check the mains voltage and if necessary, contact aftersales helpline.

TECHNICAL DATA

24V Cordless Mower CLMF2434G

Voltage	24V 
No Load Speed	3400/min
Cutting Width	34cm
Cutting Height Adjustment	20/30/40/50/60/70mm (6 Positions)
Grass Collection Box Capacity	32L
Functions	Mulch, Rear Bag
Wheel Size	140/170mm
Sound Pressure Level (L_{pA})	80dB(A) K=3dB
Sound Power Level (L_{WA}) Guaranteed	96dB(A)
Sound Power Level (L_{WA}) Measured	88.21dB(A) K=1.66dB
Vibration (a_v)	$\leq 2.5\text{m/s}^2$ K=1.5 m/s^2
Weight (Without 4.0Ah Battery)	8.59kg

CHARGER

Model No.	24LFC12
Charger Input	200-240V~50/60Hz 110W
Charger Output	24V  4.0A
Charging Period (Battery Fully Discharged)	60min (For 24LB4005)
Weight of Charger	0.5kg
Insulation Protection of Charger	<input type="checkbox"/>

BATTERY

Model No.	24LB4005
Rated Voltage of Battery	24V 
Capacity of Battery	4.0Ah
Battery Type	Lithium-Ion
Weight of Battery	0.7kg

RECYCLING AND DISPOSAL



This marking indicates that this product should not be disposed with other household wastes throughout the EU. The machine must be delivered in rigid packaging to avoid damage during transportation. The packaging and the machine itself are manufactured from recyclable materials and should be disposed of accordingly.



This appliance contains Lithium-ion battery. Do not dispose of batteries in household waste, fire or water. Dispose of batteries in accordance with the local regulations where they will be recycled in an environmentally friendly manner.

Li-ion

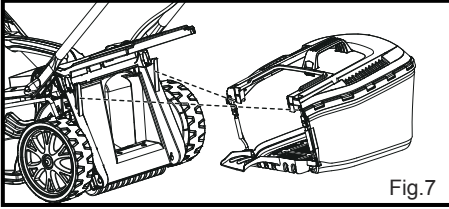

Fig. 7

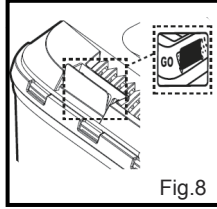

Fig. 8

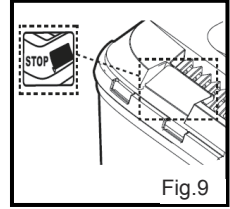

Fig. 9

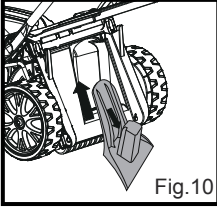

Fig. 10

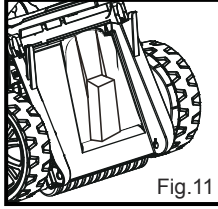

Fig. 11

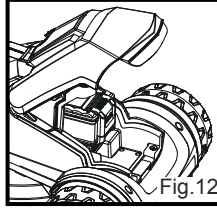

Fig. 12

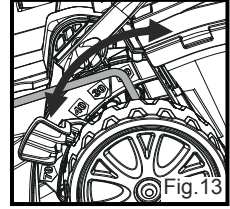

Fig. 13

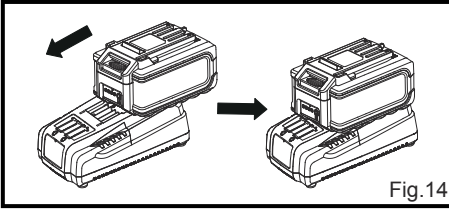

Fig. 14

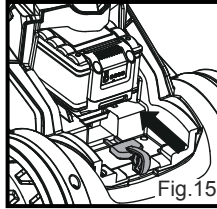

Fig. 15

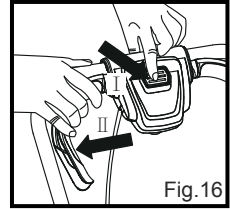

Fig. 16

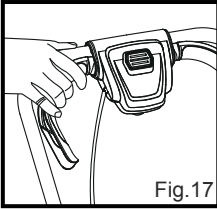

Fig. 17

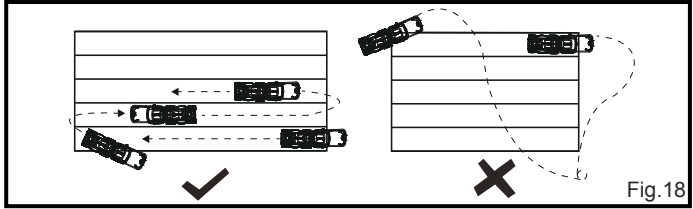

Fig. 18

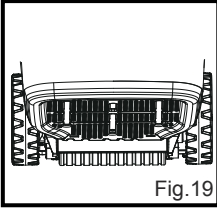

Fig. 19

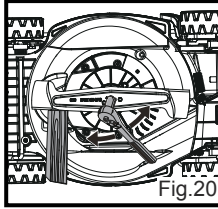

Fig. 20

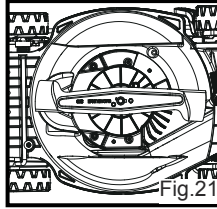

Fig. 21

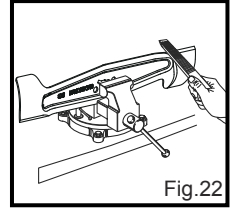

Fig. 22

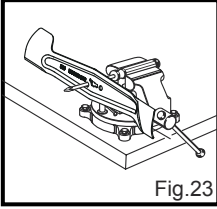

Fig. 23

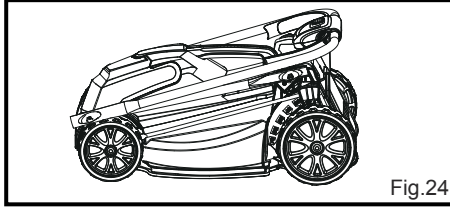

Fig. 24

CLMF2434G
Suzhou Cleva Electric Appliance Co. Ltd
8 Ting Rong Street,
Suzhou Industrial District
215122 Suzhou, Jiangsu Province, P.R.C
www.cleva-europe.com